



**Excellence in Quality
Since 1978**



OVERVIEW



I. TARGET QUALITY

II. WHY THE ELITE?

III. ENERGY SAVINGS

Better Value/Better Investment

IV. WARRANTY

V. AVAILABLE STYLES

VI. INSTALLATION





I. TARGET QUALITY



TARGET HISTORY



Target Windows & Doors began operations in 1978.

A family owned and operated business, our staff shares our traditional values.

Our goals are simple:

- **Quality**
- **Customer Satisfaction.**

These are our goals for every order placed with Target.

Each of our associates strive to deliver this on time every time.



TARGET HISTORY



In 1981, Target began manufacturing one of the first vinyl windows in the USA. Quickly becoming a leader in the industry, we haven't let up in the least. Today, our windows rank at the top of the list among our competitors. Target Windows are number one in the market today for:

- Strength & Structural Integrity**
- Energy Efficiency**
- Warranty Coverage**

Dare to compare. You won't find a more superior product...Anywhere.



TARGET PRODUCTION



One of the unique aspects of our production workflow is that we are capable of handling large volume, but we never lose sight of our attention to detail and customer service. We don't strive to be the biggest, we strive to be the BEST.



TARGET QUALITY CONTROL



Our windows don't leave the factory until we're sure that we'd install them in our own homes. Every window manufactured by Target undergoes a 35-Point Inspection to ensure the integrity of our products is never compromised.



TARGET DELIVERY



Target's own fleet of trucks ensures prompt and reliable delivery. All of our trucks are equipped with air-ride suspensions to deliver our products in perfect condition.



TARGET PRODUCT DETAILS



It all starts in the engineering and product design departments. By utilizing the finest materials available, Target has engineered a superior product that offers the latest technology as well as beauty and style.



Our vinyl is the finest uPVC available and contains absolutely **NO** recycled materials. *Ask a competitor if they can make that claim.*



TARGET PRODUCT DETAILS



The same vinyl used to manufacture Target windows is also used in some of the best products in the world.



Mercedes-Benz



GE imagination at work

Bell Helicopter

A Textron Company

TARGET PRODUCT DETAILS



We build our windows with longevity in mind. The vinyl wall thickness of our Elite Window is over 30% thicker than most windows on the market.

Target Windows:

.080 to .085



Competition:

.062 or less



A thicker wall decreases the possibility of cracking, which can lead to air and water infiltration. In addition, a thicker walled window is more resistant to distortion, twisting, and impact. The thicker frame wall also adds more insulation for increased energy savings.

Better Value - Better Investment!

TARGET PRODUCT DETAILS



Want more curb appeal?

The design of our windows *will* add that polished look to your home. However, we took “polished” to the next level. All our vinyl undergoes an extra process to literally polish the surface, resulting in an ultra-smooth finish that resists dirt and debris.

**Finest Ultra-Polished Vinyl
Stays New Looking for Years!**



NOISE REDUCTION

The combination of thicker glass, more mylar weatherstrips, more gas fill, more insulating chambers in the frame and thicker vinyl walls creates another Distinct Advantage...

Your home will be much quieter!

You'll love how much the Elite 4000 with Low E/Argon will minimize noise from the outside.



TARGET PRODUCT DETAILS



Serious Benefits...

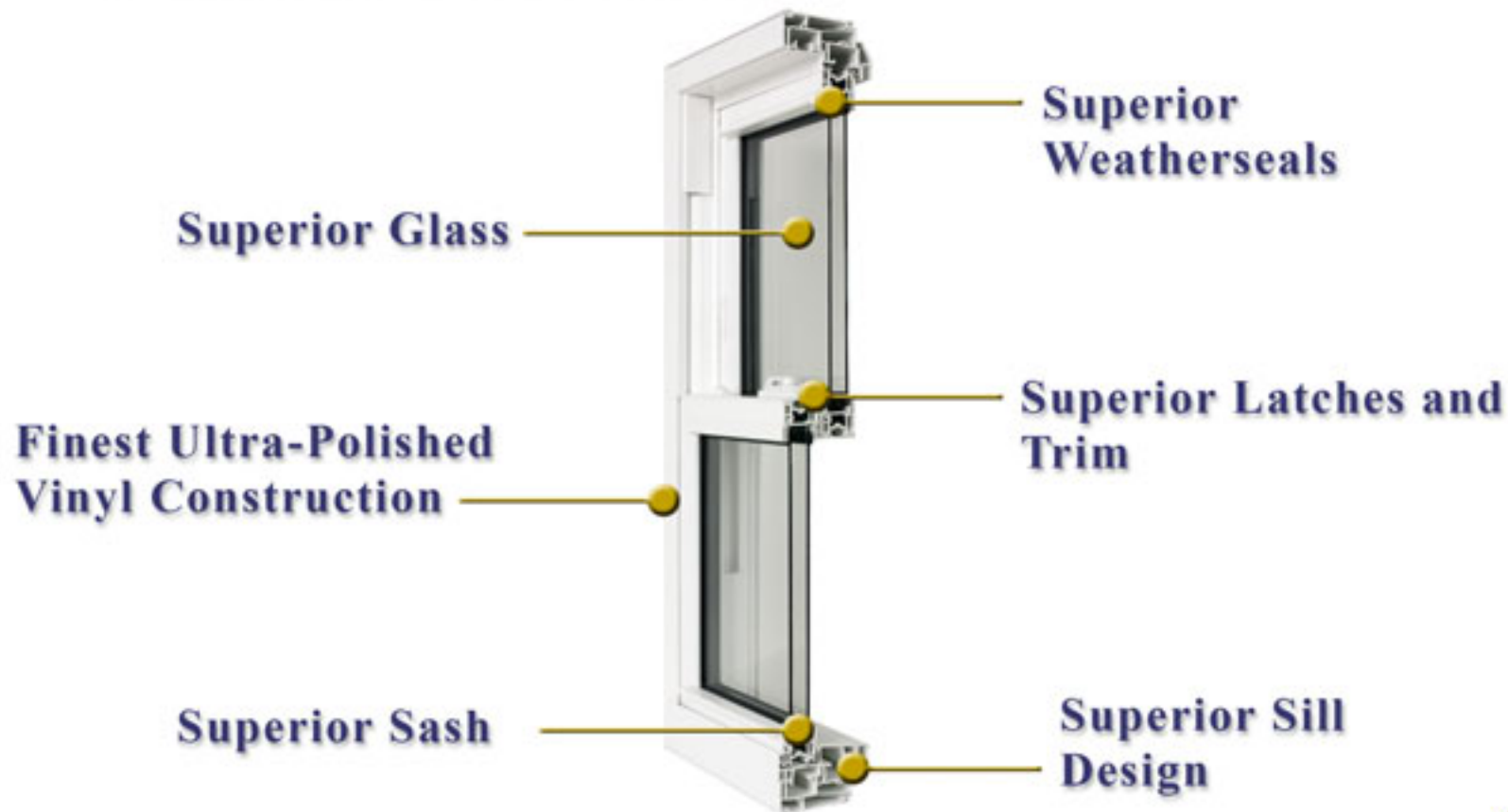

...Superior Product



II. Why the Elite?

Among the most air-tight, thermally efficient windows in the market.

With a Full Lifetime Warranty and Lifetime Glass Breakage...giving you peace of mind.



PRODUCT OVERVIEW

Elite™
4000

Target knows that your home may be the biggest investment you'll ever make, both in time and in money. Our Elite 4000 product line can free up your time with maintenance saving features, and save you money with our superior energy performance.



PRODUCT OVERVIEW

Elite™
4000

The Elite 4000 is a long term investment that literally pays for itself over time. With high-performance materials, heavy-duty construction, and classic beauty, the choice is simple: buy it once and buy it right. Buy **QUALITY** and save money.



PRODUCT OVERVIEW

The logo for Elite 4000 features the word "Elite" in a serif font with a small crown above the "i", followed by "4000" in a large, stylized, cursive font. The entire logo is set against a gold, metallic-looking background with a slight gradient and shadow.

Elite™
4000

We call our *Flagship* window the Elite because no other product on the market today can surpass our quality in:

1 Frame

2 Sash

3 Insulated Glass Seal

4 Seals

5 Screens



1 Frame

The Elite window frame has three times the insulating chambers of our competitors, offering you more energy efficiency.



More insulating chambers!

Our frames are stronger, longer lasting, more impact resistant, and have greater insulation and noise reduction qualities.



PRODUCT OVERVIEW

Elite™
4000

1 Frame

Quad-Lock Sill

A unique feature of the Elite 4000 Double Hung is our *Quad-Lock Sill* system. Along with using the industry's highest quality mylar fin weatherstripping, you can expect superior performance against air and water infiltration for a *Lifetime!*

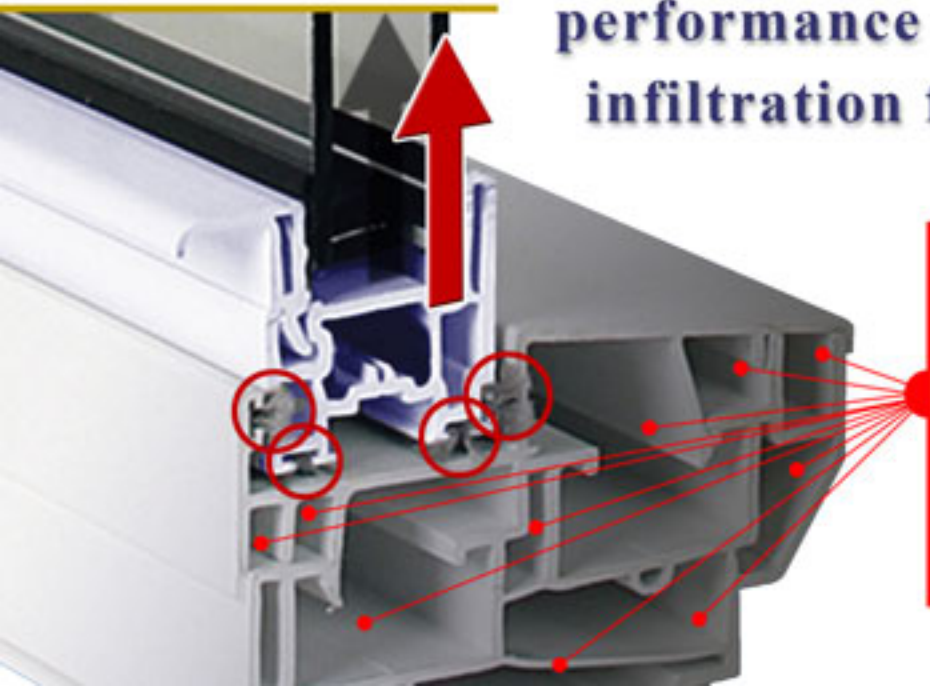

More strength chambers than the rest of the industry for superior strength and insulating value.

PRODUCT OVERVIEW

Elite™
4000

1 Frame

Easy-Lift Balance System

The *Easy-Lift* Balance System gives our double-hung windows a quiet, yet unbelievably smooth gliding operation.



2 Sash

Secure-Lock Meeting Rails

Our *Secure-Lock Meeting Rails* give your home substantially more protection than standard windows. Fully interlocking meeting rails, combined with two full rows of mylar fin weatherstrip seal out the elements and add a level of security that is unrivaled.



2 Sash



The Elite 4000 is engineered to take advantage of the superior mylar fin weatherstripping to the fullest degree.

1. We offer 4 weatherseals in our *Quad-Lock Sill*.
2. A triple weatherseal is placed where sashes meet the frame, giving you more weatherseals than other windows.
3. We also put two weatherseals at the *Secure-Lock* meeting rails.

Better Value - Better Investment

PRODUCT OVERVIEW

Elite™
4000

2 Sash



Sashes tilt in for easy cleaning.



PRODUCT OVERVIEW

Elite™
4000

2 Sash

Dual Spring-Loaded Night Latches for added security.



3 Glass

7/8” thick insulated glass units are also superior to the “standard” in the industry. We put two pieces of 1/8” thick, double-strength glass into every Elite sash manufactured. Average windows have 5/8” - 3/4” units made of weaker single strength glass.

With thicker glass panes, our windows provide better protection from the elements, minimize cracking of the glass and failure of the glass seal.



3 Glass

Argon/Krypton Gases

Argon is a safe, odorless, colorless, non-toxic, non-flammable inert gas that is used in place of air between the glass panes of an insulated Low E glass unit.

Argon is denser than regular air and thus has lower heat conductivity. This makes it a better insulator and contributes to a lower U-factor and increased noise reduction.

Krypton mixed with Argon provides even better insulating qualities when used in our Triple Glazing-R5 and better.

3 Glass

We offer truly energy-efficient glass that not only meets Energy Star criteria for U-Factor (a window rating for R-Value) but exceeds it by 20-30%. Our new High Performance Low E glass is the best available.

Dual Glazed Option
is shown:

Also available
in R-5 Triple
Glazing with
3 panes of glass

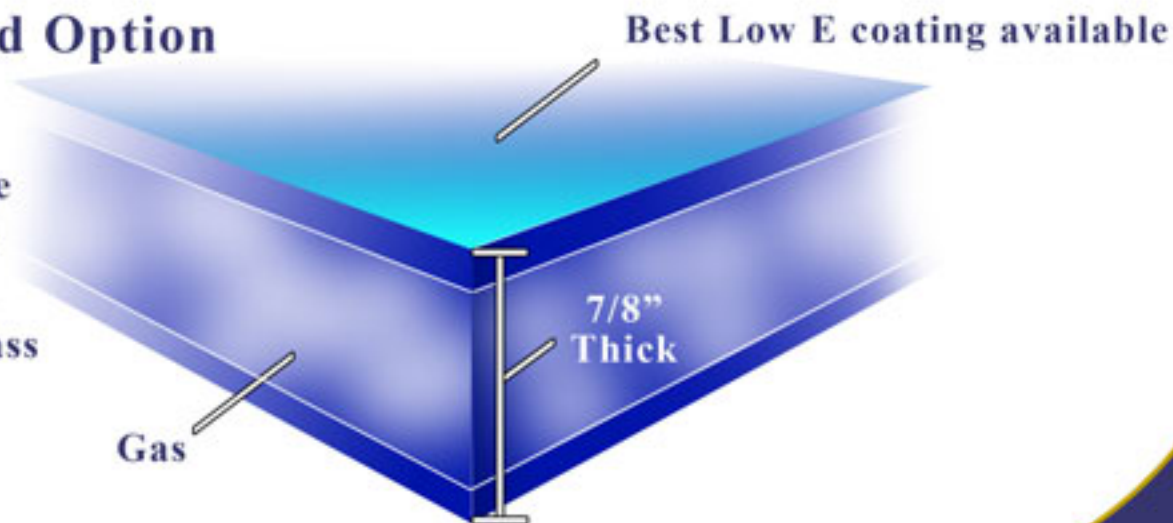

4 Insulated Glass Seal

DuraLite™ Glass Sealing System

This is the *warmest sealing system available* in a window today. Our seals contain absolutely no metal.

Due to the strength of polycarbonate composites and

superior engineering, our seals are just as strong as the metal seals found in lower quality windows, yet far more energy efficient. *Our DuraLite™ will keep your home cooler in the summer and warmer in the winter!*

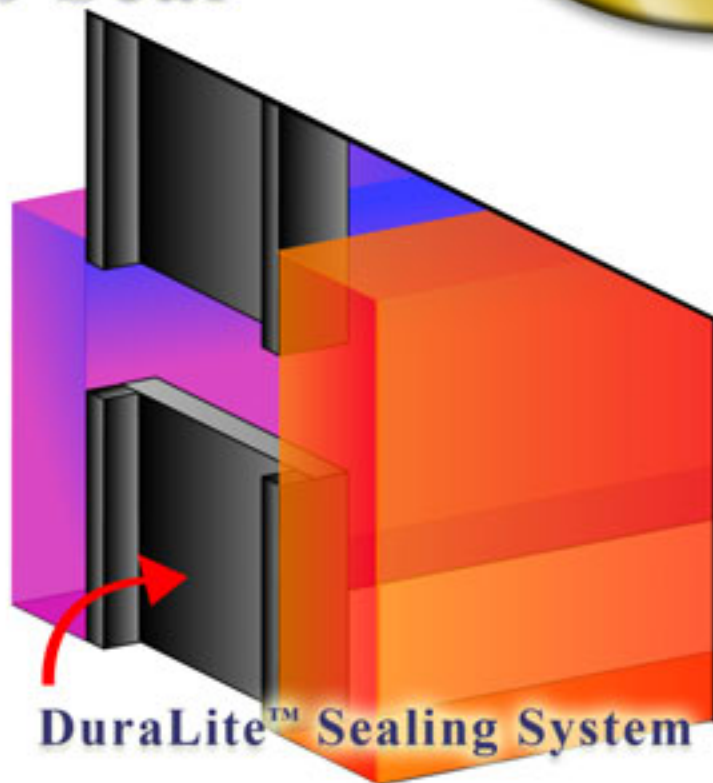

PRODUCT OVERVIEW

Elite™
4000

4 Insulated Glass Seal

DuraLite™ Glass Sealing System

Better insulating
DuraLite™ ensures
a warmer glass
temperature.

Glass Temperature

Data is based
on an outside
temperature
of 0°F, and
an interior
temperature
of 70°F.

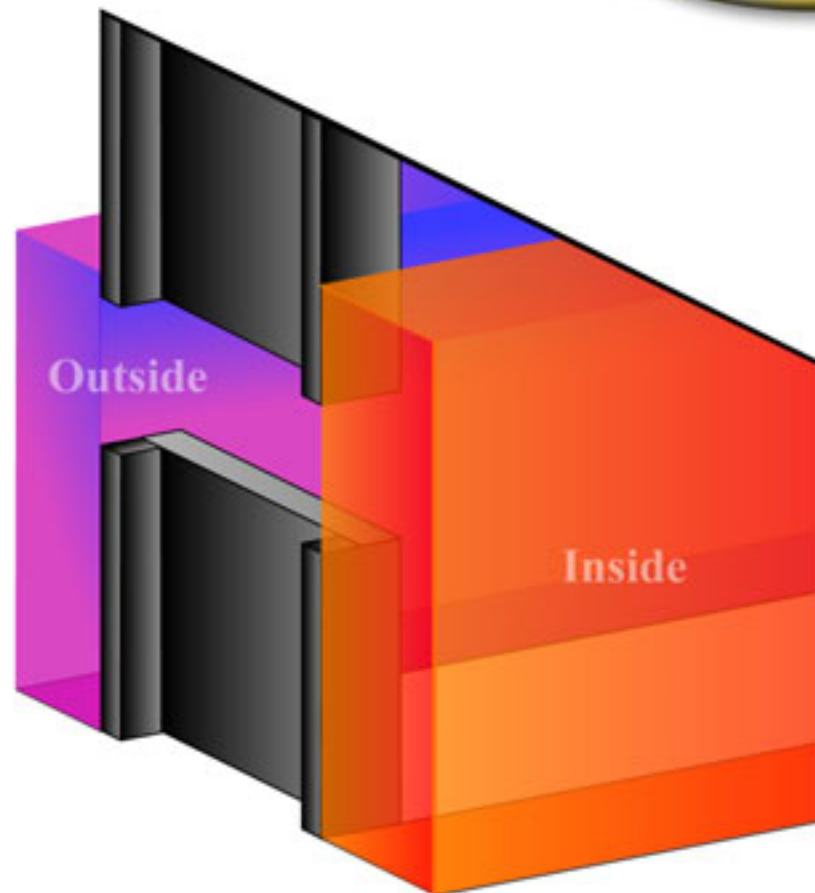
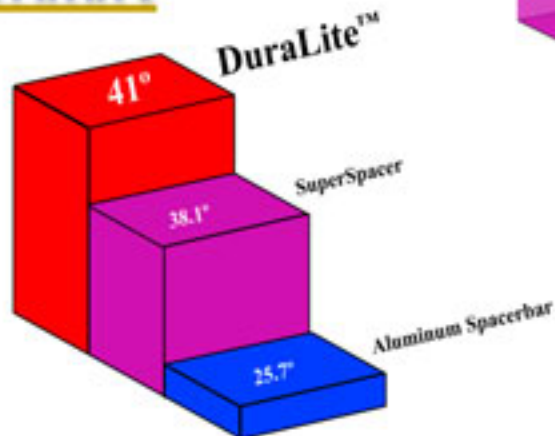

4 Insulated Glass Seal

DuraLite™ Glass Sealing System

DuraLite™ replaces the conductive materials used in other spacers with a polycarbonate hollow box increasing strength and thermal efficiency. This unique design concept creates the premier warm edge spacer on the market.



4 Insulated Glass Seal

DuraLite™ Glass Sealing System

The DuraLite™ sealing system has only one seam where other windows typically have four (one at each corner). Fewer seams equal fewer “weak points”, thus reducing seal failure and keeping the gas fill inside the window.

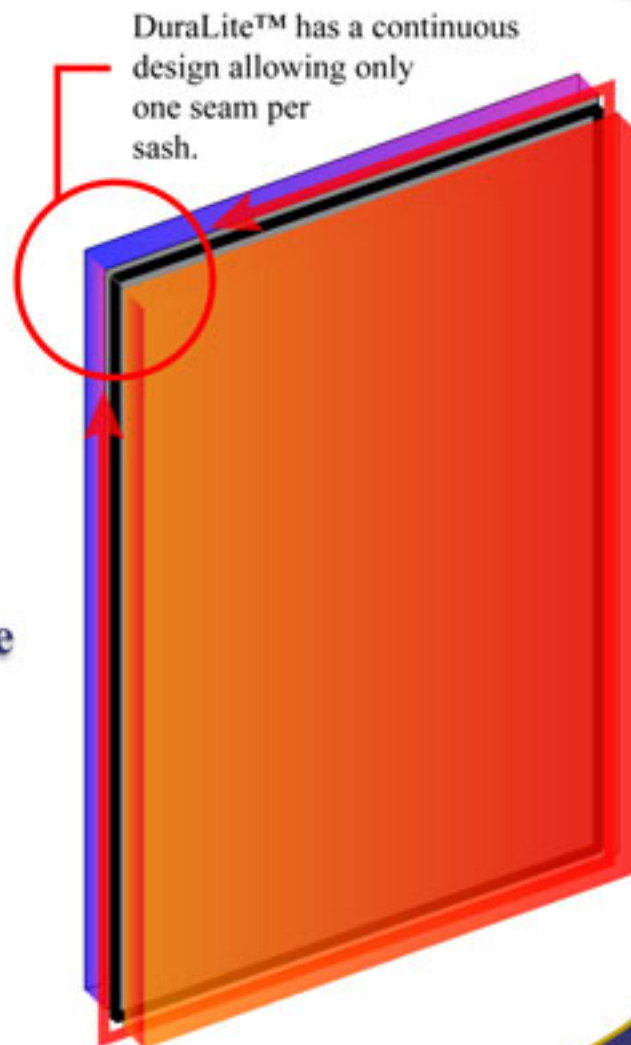

PRODUCT OVERVIEW

Elite™
4000

4 Insulated Glass Seal

DuraLite™ Glass Sealing System

Similar to R-Value measurements for insulation, U-Value is how the U.S. Department of Energy measures the thermal efficiency of windows. The warmer the glass edge, the lower the U-Value. *With a Low E U-Value of .28, our Elite 4000 Series WILL save you more money.*

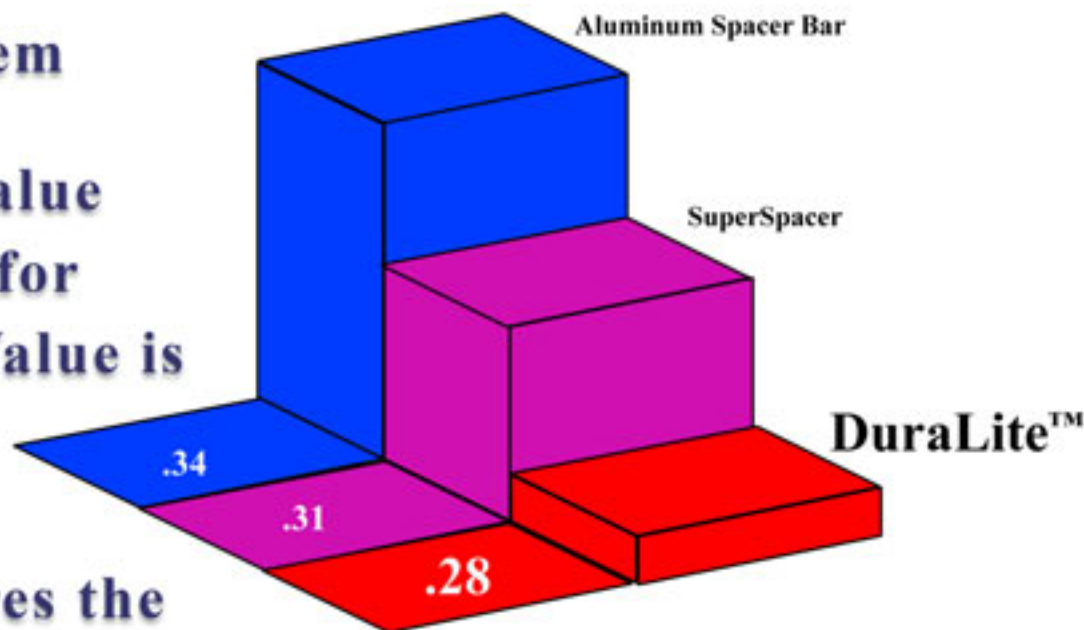

5 Screens

The screen in our Elite 4000 Double-Hung is *extruded* aluminum with a wall thickness of .045". The typical screen used is a *roll-formed* aluminum screen with only a .020" wall thickness.

Why extruded?

Superior Strength/Superior Durability

Better Value - Better Investment



III. Energy Savings

*Better Value/
Better Investment*



ENERGY EFFICIENCY

EliteTM
4000

Just How Efficient?

Our Low E/Argon Glass exceeds all U-Value Energy Star ratings nationwide by 20-30%!!

Our U-Values are as low as .19!

Correlating into an R-5.26 for the entire window!

Most builder's grade windows have a U-Value of approximately .55, making our Elite 4000 twice as efficient. This saves you more on monthly heating and cooling costs.



ENERGY EFFICIENCY

EliteTM
4000

Monthly Utility Bills

When you analyze the cost of monthly heating and cooling bills, *you won't believe how quickly your savings will add up.*

Your Elite 4000 windows will literally pay for themselves!



ENERGY EFFICIENCY



Add Resale Value!

When you go to sell your home, our windows become an asset to the buyer. *The latest "Remodeling Magazine" Cost vs. Value Report shows an 84.7% return on your investment if you were to sell your home immediately after getting our Elite 4000 window installed.*



An efficient home is much easier to sell.

With a *Lifetime Transferrable Warranty*, your buyer will enjoy the same comfort and quality with the same peace of mind.

ENERGY EFFICIENCY

Elite™
4000

Elite 4000 vs. The Competition

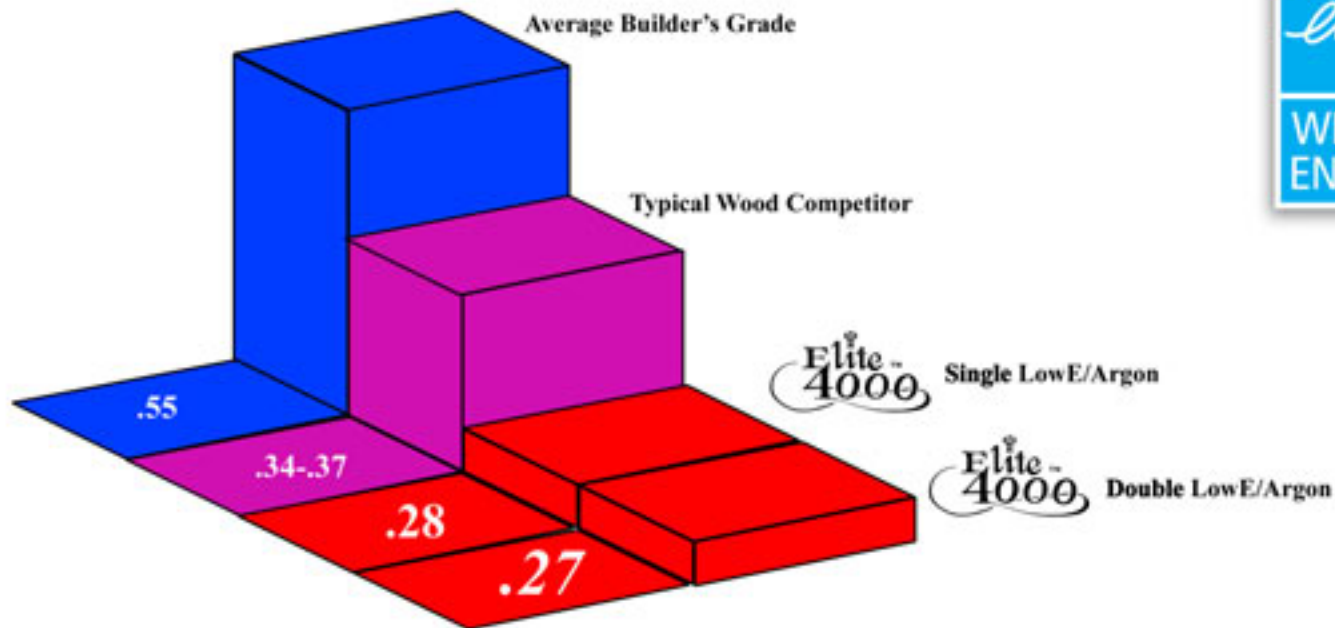

In comparison to the top brand wood windows with LowE/Argon, the Elite 4000 with LowE/Argon is as much as **40% more** thermally efficient than wood.

LOW MAINTENANCE

EliteTM
4000

Elite 4000 vs. Top Brand Wood Windows

Wood windows require repetitive staining, sealing or painting to maintain their appearance and prevent rotting. The Elite 4000 requires virtually no maintenance, and will give you a lifetime of beauty and performance.

**Virtually no
maintenance!**



ENERGY EFFICIENCY



Elite 4000 vs. Top Brand Wood Windows

A big advantage the Elite 4000 has over a wood window is the overall thickness of its glass units. Wood windows typically have a thickness of 1/2" - 5/8", whereas the Elite 4000 has a thickness of 7/8". This leaves a larger space between the two panes of glass, giving the Elite 4000 a larger chamber to hold more insulating gas.



*More gas + DuraLite™ Seals + Comfort Ti Glass =
Your Best Choice in Thermally Efficient Windows*

LOW MAINTENANCE



Elite 4000 vs. Top Brand Wood Windows

The beauty of wood is also available on the Elite 4000. Our vinyl composite can be made to look just like a wood window. The only person who will know that your windows are really vinyl is you.



The Elite 4000

- *Woodgrain interiors*
- *Superior Thermal Efficiency*
- *Virtually No Maintenance*
- *Lower Costs*

*Choose the Elite 4000
and get the same
elegance without all
the maintenance.
Plus Save Energy!*

IV. Warranty



WARRANTY

Lifetime and *Transferrable*



The Elite 4000 comes with a Lifetime Non-Prorated Fully Transferrable Warranty. This warranty also covers glass breakage for the life of the window.

We encourage you to read the fine print on all warranties, and you'll find that the Elite warranty is the strongest on the market.

WARRANTY

Elite™
4000

Add Resale Value!

The Lifetime *Transferrable* Warranty
also covers glass breakage!!



1

V. Available Styles



AVAILABLE STYLES

Elite™
4000

Customizing the Elite 4000™

The Elite 4000 is available in a wide variety of styles and options.



Double-Hung



Oriel



Reverse Oriel

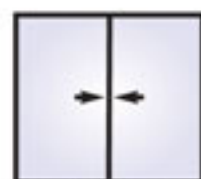

2-Panel Lift-Out Slider



2-Panel Tilt Slider

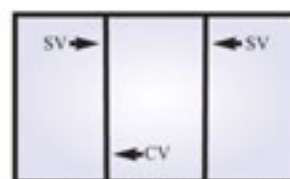

3-Panel Side or Center Vent Slider



Picture



Casement



Awning



Bay Unit



Bow Unit



Special Shapes

All Units can be mulled together to form a wide variety of stylish configurations!

AVAILABLE STYLES



Customizing the Elite 4000™

The Elite 4000 is available in a wide variety of Colors, Glass Choices, and Screen Mesh options.

Colors: White, Beige, and Standard or Custom Painted Exteriors, and Woodgrain Interiors

Glass Choices: Clear, LowE/Argon, Obscure, Tinted, Tempered or Decorative

Screen Mesh: Charcoal Fiberglass, Charcoal or Bright Aluminum, and Better-Vu Screen (for a better view)

With our woodgrain interiors, and standard or custom exteriors, the choice of finish options is amazing!!



AVAILABLE STYLES

Elite™
4000

Beauty in any style

Double-Hung

The design of the Elite 4000 Double-Hung combines great looks with first class performance, offering you a dramatic upgrade as replacement windows or initial elegance for your new home.



AVAILABLE STYLES

Elite™
4000

Beauty in any style

Sliding Windows

The Elite 4050 2-Panel Slider and 4100 3-Panel Slider feature beveled outer frames for a softer appearance. A continuous handle rail and brass rollers allow the sashes to open and close easily.



AVAILABLE STYLES

Elite™
4000

Beauty in any style

Bay Windows

Add space and value to your home with an eye catching Elite Bay Window...Double-Hung or Casement model. The large center section gives an expansive view and the birch or red oak seat board provides the beauty of natural wood.



*Casement Bay
with Diamond Muntins*



*Bay with Colonial Muntins
and Double-Hung in Center*



AVAILABLE STYLES

Elite™
4000

Beauty in any style

Bow Windows

Equal lite Casements and Picture Windows form the gentle curve of an Elite Bow Window. The sweeping, panoramic view adds distinctive style and beauty to your home.



*Available in 3, 4, 5,
or 6 sections.*

AVAILABLE STYLES

Elite™
4000

Beauty in any style

Casement - Triple Seal

The smooth operating Elite 4400 Casement has a multi-point locking system for greater security and superior air tightness. Corrosion resistant gearing provides years of worry free operation.

Among the most air tight and thermally efficient windows in the market. R-5 Triple Pack Available.

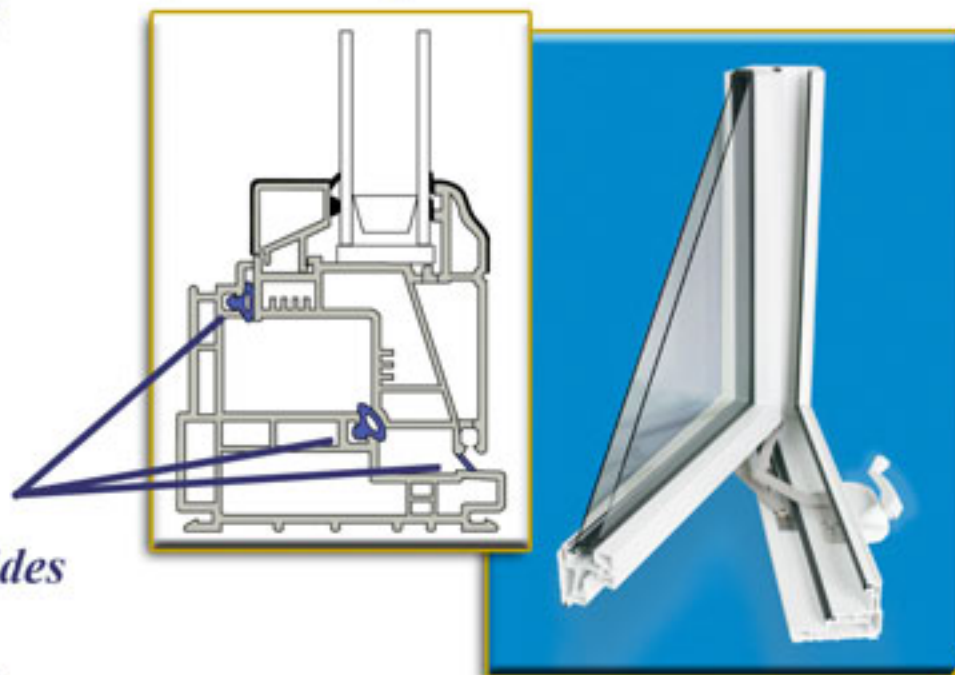

Triple Seal engineering provides superior thermal efficiency, putting our casement/awning above the rest!!

AVAILABLE STYLES

Elite™
4000

Beauty in any style

Picture Windows & Shapes

Bring in the light and enhance your view of the world with the many shapes and sizes of the Elite 4150 Picture Windows.



Add our standard Low E/Argon Glass and achieve a .25 U-Value!

Ask how you can achieve an R-5.26 (19U Value).

AVAILABLE STYLES

Elite™
4000

Beauty in any style

Awning

The Elite 4450 Awning Window tilts outward at the bottom, allowing ventilation even on wet, rainy days. Awnings can be mulled to other window styles for creative ventilation solutions.

*Add our Low E/
Argon Glass and
achieve a .26
U-Value!*

*Add our R-5
Triple Pack
and achieve a
.19 U-Value R-5.26*



AVAILABLE STYLES



Decorative Glass Options

Architectural Accent Glass

The look of camed art glass at a fraction of the cost. Three decorative shapes available.



AVAILABLE STYLES

Elite™
4000

Muntin Bar Options

Mounted Between Glass for No Maintenance

Styles



Flat

*Available in Colonial,
Single Prairie, and Diamond*



Contoured

*Available in Colonial
and Single Prairie*



Rounded

*Pewter or Brass tone
in Single Prairie*

Configurations



Colonial



Diamond

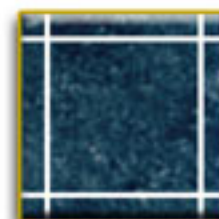

Single Prairie

AVAILABLE STYLES

Elite™
4000

Polished Brass Sash Locks

Option for Double-Hung and Sliding Windows



Add Your Personal Touch!



AVAILABLE STYLES

Elite™
4000

Flip-Out Vent Stop

Option for Sliding Windows

- Excellent deterrent for forced entry

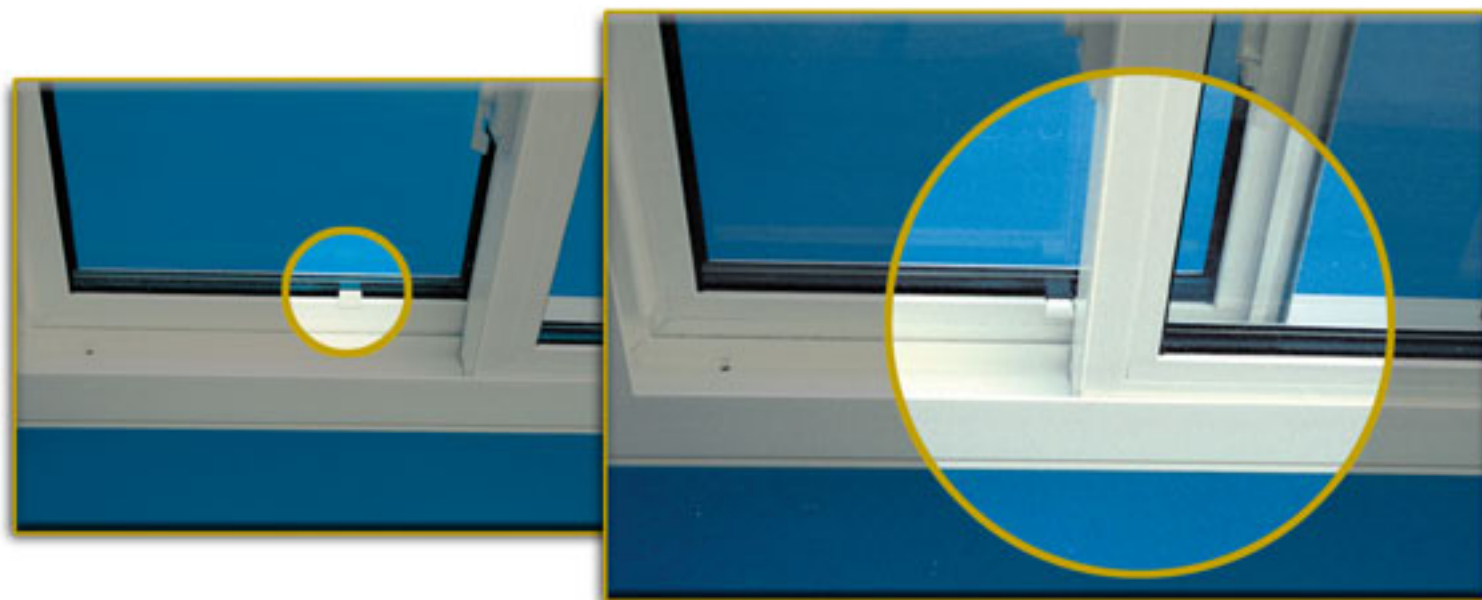

VI. Installation



INSTALLATION

Our windows are measured and custom fit to your home. This ensures a perfect installation whether it be for new construction or replacement of your current windows.

With the strength and durability of the Elite 4000 frame, our window units are square and built to stay that way, not like some of the lighter weight vinyl windows on the market. This makes installation easier and less prone to “out-of-square installations”.





**When buying your
windows the choice is
simple: buy it once and
buy it right.
Buy QUALITY
and save money.**

